



2 x  2 x  1 x 



For installation, use expansion plug suitable for wall construction.

Not recommended for plaster walls.

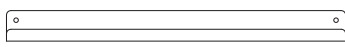
Max. load 5 kg

1.

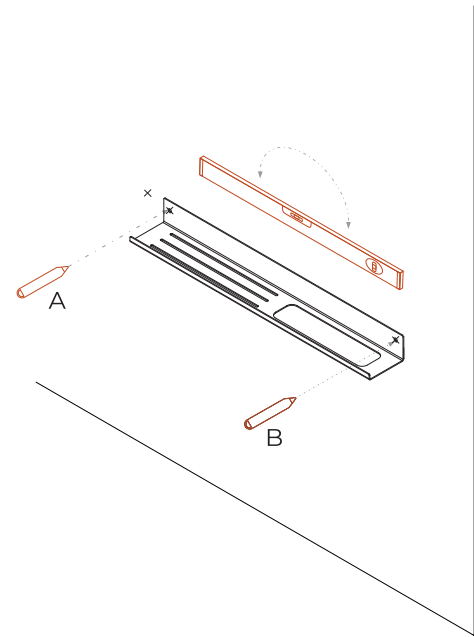

2.

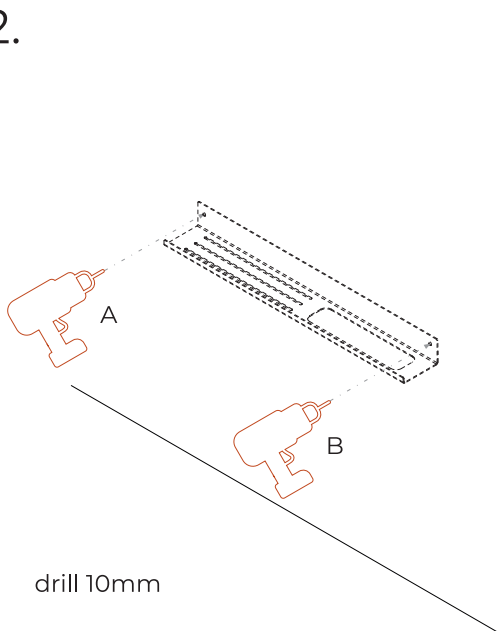

3.

